

# iQ PLUS Stationary Tables

## Cast Aluminum Pedestals

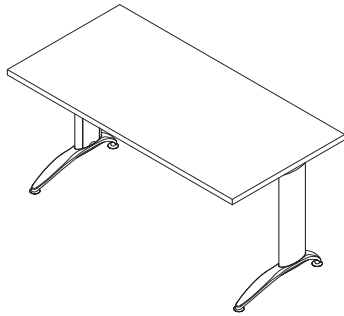

High Pressure Laminate Surface					
Edge Style, Type and Size					
Self	Vinyl T-Mold		Specialty PVC	Wood	
	L-21			W-23	
1/16"x1-1/4"	L-18	L-23		W-18	W-19
P-12	L-15	L-20	P-14	W-16	W-17
1/8"x1-1/4"	1/4"x1-1/4"	1/4"x1-3/4"	2mmx1-1/4"	1-1/4"x1-1/4"	1-1/4"x1-3/4"

Table Model	Base Model	List Price					
		Textured & Smooth Pedestal Finishes					
IOS-2448	IOEB-22	\$879	\$880	\$958	\$923	\$1337	\$1414
IOS-2460	IOEB-22	920	923	1011	966	1399	1479
IOS-2472	IOEB-22	1034	1036	1151	1085	1518	1610
IOS-2484	IOEB-22	1102	1105	1238	1158	1864	1994
IOS-2496	IOEB-22	1268	1271	1444	1331	2108	2261
IOS-3048	IOEB-22	926	927	1012	971	1416	1501
IOS-3060	IOEB-22	975	979	1080	1023	1502	1596
IOS-3072	IOEB-22	1063	1067	1188	1116	1621	1725
IOS-3084	IOEB-22	1160	1163	1311	1218	1891	2024
IOS-3096	IOEB-22	1266	1268	1442	1329	2237	2402
IOS-3648	IOEB-28	1046	1048	1161	1098	1480	1568
IOS-3660	IOEB-28	1088	1090	1214	1143	1636	1739
IOS-3672	IOEB-28	1138	1140	1275	1196	1774	1891
IOS-3684	IOEB-28	1356	1358	1550	1425	2190	2350
IOS-3696	IOEB-28	1471	1473	1693	1545	2310	2481

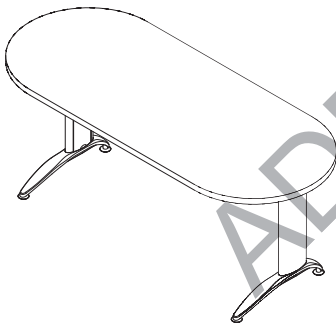









Table Model	Base Model	List Price					
		Textured & Smooth Pedestal Finishes					
IOSR-3672	IOEB-28	C/F	\$1412	\$1557	C/F	\$2385	\$2799
IOSR-3684	IOEB-28	C/F	1608	1825	C/F	2729	3141
IOSR-3696	IOEB-28	C/F	1815	2072	C/F	2956	3401

√ V-12 Framed Edge.

**Berco Customer Service (888) 772-4788**

High Pressure Laminate or Veneer Surface (V)  
Edge Style, Type and Size

	Wood	Wood/Veneer			
					
					
					
					
	<b>W-34</b>	<b>V-12</b> ✓	<b>V-16</b>	<b>V-17</b>	
	2-1/2"x1-1/4"	1/8"x1-1/4"	1-1/4"x1-1/4"	1-1/4"x1-3/4"	

Self, Vinyl, PVC, and Wood Edge  
Laminate or Veneer Surface

Table Specifications . . . . . 76  
How to Order . . . . . 77  
Surface Selections . . . . . 198  
Edge Specifications . . . . . 199-205  
Pedestal Finish Selections . . . . . 207  
Table and Base Options . . . . . 208-219  
Power & Data Options . . . . . 214-217  
Design Data . . . . . 220-227

Options - Add To List Price

List Price Textured & Smooth Pedestal Finishes				Metallic	2 Flip Tops w/bridge	Adjustable Height	Special Height	iQ Plus PMP	Casters	Table Locks "D"
\$1533	\$2022	\$2108	\$2224	\$142	\$253	\$1368	\$161	\$267	\$200	\$66 Per Lock Factory Installed  Please Provide Table Layout Drawing Or See Page 218 For Table Configurations  Recommended For Flat Edges Only L-10, L-18, L-20, L-21, P-12, P-14, W-16, W-17, V-12, V-16, V-17  Hardware only For Field Installation \$33
1599	2064	2159	2270	142	253	1368	161	304	200	
1728	2173	2270	2396	142	253	1368	161	322	200	
2109	2595	2727	2879	142	253	1368	161	367	200	
2388	2813	2958	3126	142	253	1368	161	378	200	
1618	2159	2261	2386	142	253	1368	161	267	200	
1714	2153	2249	2373	142	253	1368	161	304	200	
1842	2339	2451	2589	142	253	1368	161	322	200	
2136	2589	2713	2872	142	253	1368	161	367	200	
2542	2900	3046	3227	142	253	1368	161	378	200	
1686	2443	2561	2705	146	253	1368	161	267	200	
1856	2595	2727	2880	146	253	1368	161	304	200	
2006	2695	2819	2985	146	253	1368	161	322	200	
2482	2980	3126	3308	146	253	1368	161	367	200	
2624	3228	3387	3590	146	253	1368	161	378	200	

Using Casters with adjustable height increases minimum overall height:

iQ Plus adjustable height range with glides: 29" to 40.5"  
iQ Plus adjustable height range with casters: 32" to 43.5"  
Adjustable height tables not available in chrome or metallic

ADD TO LIST PRICES

List Price Textured & Smooth Pedestal Finishes				Metallic	2 Flip Tops w/bridge	iQ Plus PMP	Casters
\$4291	\$3858	\$4058	\$4310	\$146	\$253	N/A	\$200
4796	4130	4344	4618	146	253	N/A	200
5217	4495	4740	5043	146	253	N/A	200

iQ Plus Stationary

For additional top sizes see pages 176-197.

C/F = Consult Factory

Thirty ( 30 ) Year Warranty

# iQ PLUS Stationary Tables

## Cast Aluminum Pedestals

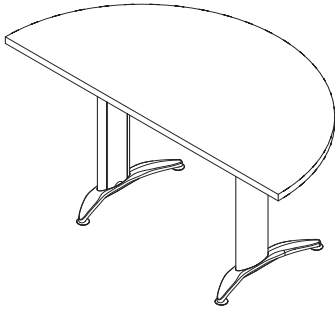

High Pressure Laminate Surface					
Edge Style, Type and Size					
Self	Vinyl T-Mold		Specialty PVC	Wood	
	L-21			W-23	
1/16"x1-1/4"	L-18	L-23		W-18	W-19
P-12	L-15	L-20	P-14	W-16	W-17
1/8"x1-1/4"	1/4"x1-1/4"	1/4"x1-3/4"	2mmx1-1/4"	1-1/4"x1-1/4"	1-1/4"x1-3/4"

Table Model	Base Model	List Price					
		Textured & Smooth Pedestal Finishes					
IOSH-60	IOEB-22	\$1060	\$1059	\$1203	\$1112	\$2002	\$2143
IOSH-72	IOEB-28	1250	1248	1443	1313	2407	2586

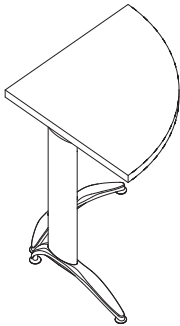

IOSQ-24	No Base	\$387	\$366	\$436	\$407	\$863	\$934
IOSQ-30	IOEB-22	895	894	988	940	1483	1574
IOSQ-36	IOEB-28	1000	997	1119	1051	1636	1740

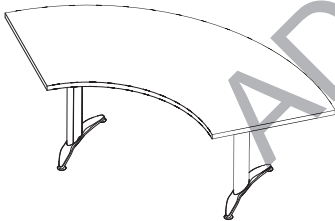

IOSC-24	IOEB-22	\$1267	\$1252	\$1454	\$1330	\$2249	\$2416
IOSC-30	IOEB-22	1856	1852	2231	1949	3658	3966
IOSC-36	IOEB-28	2296	2293	2796	2411	4601	4999

iQ Plus Stationary

Berco Customer Service (888) 772-4788

Self, Vinyl, PVC, and Wood Edge  
Laminate or Veneer Surface

Table Specifications . . . . . 76  
 How to Order . . . . . 77  
 Surface Selections . . . . . 198  
 Edge Specifications . . . . . 199-205  
 Pedestal Finish Selections . . . . . 207  
 Table and Base Options . . . . . 208-219  
 Power & Data Options . . . . . 214-217  
 Design Data . . . . . 220-227

Options - Add To List Price

Metallic	2 Flip Tops w/bridge	Special Height	Casters
\$142	\$253	\$161	\$200
146	253	161	200
--	N/A	N/A	N/A
142	N/A	N/A	200
146	N/A	N/A	200
\$142	\$253	\$161	\$200
142	253	161	200
146	253	161	200

Table  
Locks "D"

\$66 Per Lock  
Factory Installed

Please Provide  
Table  
Layout Drawing  
Or  
See Page 218  
For Table  
Configurations

Recommended  
For  
Flat Edges Only  
L-10, L-18,  
L-20, L-21, P-12,  
P-14,  
W-16, W-17,  
V-12, V-16, V-17

Hardware only  
For  
Field Installation  
\$33

ADD 7% TO PRICES

iq Plus Stationary

For additional top sizes see pages 176-197.

Thirty ( 30 ) Year Warranty

# iQ PLUS Stationary Tables

## Cast Aluminum Pedestals

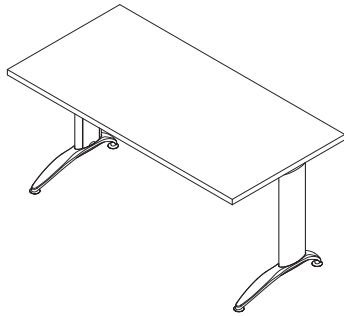





High Pressure Laminate Surface					
Edge Style, Type and Size					
Comfort Edge					
Aluminum W/PVC Edge (E10 Ebony PVC only)	Laminate Post Form W/PVC Edge (E10 Ebony PVC only)	Textured Tough Edge 3 sides PVC	Wood W/PVC Edge (E10 Ebony PVC only)	Wood W/3MM Wood	Wood 4 Sides
					
AC-9	LC-9	TC-9	WC-9	WC-11	W-35
2"x1-1/4"	2"x1-1/4"	2"x1-1/4"	2"x1-1/4"	2"x1-1/4"	2"x1-1/4"

Table Model	Base Model	List Price					
		Textured & Smooth Pedestal Finishes					
IOS-2448	IOEB-22	\$954	\$929	\$956	\$1231	\$1352	\$1533
IOS-2460	IOEB-22	1000	969	1038	1286	1418	1599
IOS-2472	IOEB-22	1109	1061	1087	1364	1498	1728
IOS-2484	IOEB-22	N/A	1138	1185	1444	1618	2109
IOS-2496	IOEB-22	N/A	1271	N/A	1511	1713	2374
IOS-3048	IOEB-22	1000	969	956	1258	1378	1618
IOS-3060	IOEB-22	1056	1021	1013	1324	1498	1714
IOS-3072	IOEB-22	1149	1088	1129	1432	1607	1842
IOS-3084	IOEB-22	N/A	1179	1252	1526	1686	2136
IOS-3096	IOEB-22	N/A	1271	N/A	1618	1779	2516
IOS-3648	IOEB-28	1122	1018	N/A	1307	1441	1686
IOS-3660	IOEB-28	1167	1123	N/A	1441	1561	1856
IOS-3672	IOEB-28	1224	1188	N/A	1507	1667	2006
IOS-3684	IOEB-28	N/A	1352	N/A	1601	1775	2462
IOS-3696	IOEB-28	N/A	1451	N/A	1709	1882	2593

iQ Plus Stationary



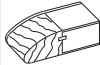

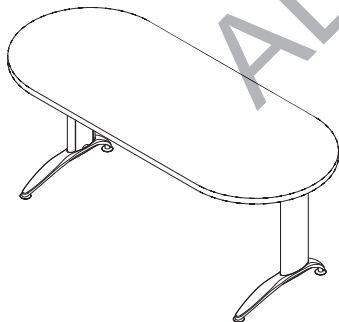



High Pressure Laminate Surface		
Edge Style, Type and Size		
Comfort Edge		
Laminate Post Form W/PVC Edge (E10 Ebony PVC only)	Textured Tough Edge 3 Sides PVC	Wood 4 Sides
		
LC-9	TC-9	W-35
2"x1-1/4"	2"x1-1/4"	2"x1-1/4"

Table Model	Base Model	List Price		
		Textured & Smooth Pedestal Finishes		
IOSR-3672	IOEB-28	N/A	N/A	\$3463
IOSR-3684	IOEB-28	N/A	N/A	3889
IOSR-3696	IOEB-28	N/A	N/A	4211

Wood edges on Linoleum tops available only in natural finish.

**Berco Customer Service (888) 772-4788**

High Pressure Laminate or Linoleum Surface (V)  
Edge Style, Type and Size

Wood		
3mm Wood Laminate Top	Euro Wood	Linoleum Top Surface **
		 W-22L
W-12√	W-22	W-12L
1/8"x1-1/4"	1-1/8"	Add

Comfort Edge and Wood Edge  
Laminate or Linoleum Surface

Table Specifications . . . . . 76  
How to Order . . . . . 77  
Surface Selections . . . . . 198  
Edge Specifications . . . . . 199-205  
Pedestal Finish Selections . . . . . 207  
Table and Base Options . . . . . 208-219  
Power & Data Options . . . . . 214-217  
Design Data . . . . . 220-227

Options - Add To List Price

List Price Textured & Smooth Pedestal Finishes	Metallic	2 Flip Tops w/bridge	Adjustable Height	Special Height	iQ Plus PMP	Casters	Table Locks "D"	
\$1096	\$997	\$115	\$142	\$253	\$1368	\$161	\$267	\$200
1118	1175	164	142	253	1368	161	304	200
1278	1333	165	142	253	1368	161	322	200
1514	1454	250	142	253	N/A	161	367	200
1659	1598	265	142	253	N/A	161	378	200
1169	1101	189	142	253	1368	161	267	200
1211	1239	170	142	253	1368	161	304	200
1352	1399	179	142	253	1368	161	322	200
1661	1619	249	142	253	N/A	161	367	200
1747	1903	269	142	253	N/A	161	378	200
1275	1174	190	146	253	1368	161	267	200
1329	1300	164	146	253	1368	161	304	200
1471	1528	172	146	253	1368	161	322	200
1736	1868	278	146	253	N/A	161	367	200
1805	1967	297	146	253	N/A	161	378	200

\$66 Per Lock  
Factory Installed

Please Provide  
Table  
Layout Drawing  
Or  
See Page 218  
For Table  
Configurations



Recommended  
For  
Flat Edges Only  
AC-9, LC-9,  
TC-9, WC-9, WC-  
11, W-12,  
W-22

Hardware only  
For  
Field Installation  
\$33

Using Casters with adjustable height increases minimum overall height:

iQ Plus adjustable height range with glides: 29" to 40.5"  
iQ Plus adjustable height range with casters: 32" to 43.5"  
Adjustable height tables not available in chrome or metallic

High Pressure Laminate or Linoleum Surface  
Edge Style, Type and Size

Wood		
3mm Wood Laminate Top	Euro Wood	Linoleum Top Surface **
		 W-22L
W-12	W-22	W-12L
1/8"x1-1/4"	1-1/8"	Add

\*\* Price for Linoleum add-on must be added to price of W-22 or W-12 tops.

List Price Textured & Smooth Pedestal Finishes	Metallic	2 Flip Tops w/Bridge	Special Height	Casters
N/A	\$2027	\$172	\$146	\$253
N/A	2309	278	146	253
N/A	2494	297	146	253

√ V-12 Framed Edge.  
For additional top sizes see pages 176-197.

C/F = Consult Factory

Thirty ( 30 ) Year Warranty

iQ Plus Stationary

# iQ PLUS Stationary Tables with DogBone™ Connectors

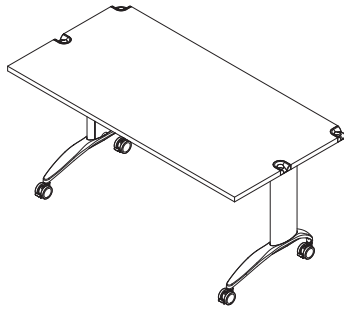

High Pressure Laminate or Linoleum Surface  
Edge Style, Type and Size

PVC	Wood	Euro Wood	Comfort Edge		
			Aluminum w/PVC 3 Sides	Wood w/PVC 3 Sides	Wood W/3MM Wood 3 Sides
P-12DB	W-12DB	W-22DB	AC-9	WC-9DB	WC-11DB
1/8"x1-1/4"	1/8"x1-1/4"	1-1/8"	1-1/4"	2"x1-1/4"	2"x1-1/4"

Table Model	Base Model	List Price					
		Textured & Smooth Pedestal Finishes					
IOS-2448	IOEB-22	\$1159	\$1376	\$1277	\$1234	\$1511	\$1632
IOS-2460	IOEB-22	1200	1397	1455	1280	1565	1698
IOS-2472	IOEB-22	1314	1558	1613	1389	1644	1778
IOS-2484	IOEB-22	1382	1794	1733	N/A	1724	1898
IOS-2496	IOEB-22	1548	1939	1878	N/A	1790	1993
IOS-3048	IOEB-22	1205	1448	1381	1280	1536	1658
IOS-3060	IOEB-22	1254	1491	1519	1336	1604	1778
IOS-3072	IOEB-22	1343	1632	1677	1429	1712	1887
IOS-3084	IOEB-22	1440	1941	1899	N/A	1805	1966
IOS-3096	IOEB-22	1546	2027	2183	N/A	1898	2059
IOS-3648	IOEB-28	1326	1555	1454	1402	1587	1721
IOS-3660	IOEB-28	1367	1609	1580	1447	1721	1841
IOS-3672	IOEB-28	1418	1751	1808	1504	1787	1946
IOS-3684	IOEB-28	1636	2015	2148	N/A	1881	2055
IOS-3696	IOEB-28	1751	2085	2247	N/A	1988	2162

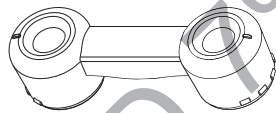

The DogBone™

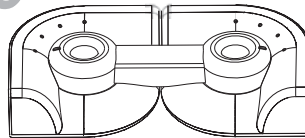

The DogBone™ seated in corner sockets

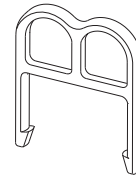

DogBone™ Puller

Berco's iQ Plus stationary tables with DogBone™ Connectors are preconfigured with Locking Casters to maximize the functionality of the table system. The DogBone™ connection system offers a distinct look with exceptional versatility.

iQ Plus stationary tables with DogBone™ Connectors are also available with our Comfort Edge. This edge is perfect for training applications, increasing the comfort of the student, and maximizing the effectiveness of the facility.

iQ Plus stationary tables with DogBone™ Connectors can be configured in a multitude of ways as shown on page 85. The tables can then be easily reconfigured with a minimum of effort.

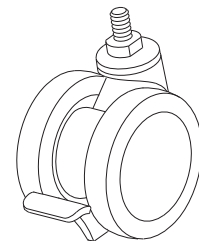

Aluminum, PVC, Euro Wood, and Wood Edge  
Laminate or Linoleum Surface

Table Specifications . . . . . 76  
 How to Order . . . . . 77  
 Surface Selections . . . . . 198  
 Edge Specifications . . . . . 199-205  
 Pedestal Finish Selections . . . . . 207  
 Table and Base Options . . . . . 208-219  
 Power & Data Options . . . . . 214-217  
 Design Data . . . . . 220-227

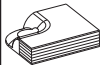
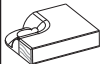
Linoleum Top Surface **

W-22DBL

W-12DBL
Add

Options - Add To List Price

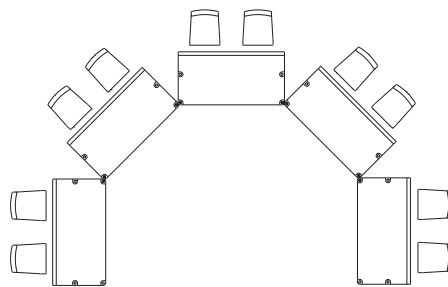
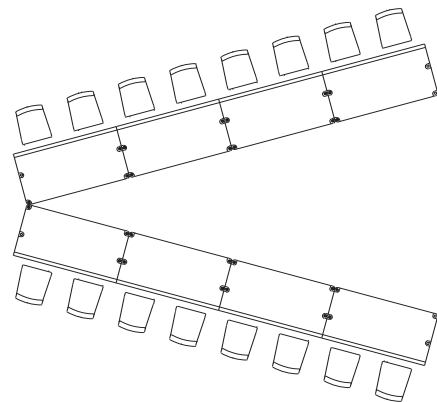
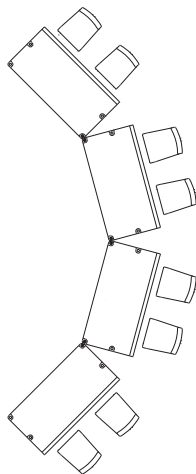
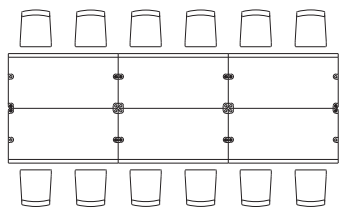
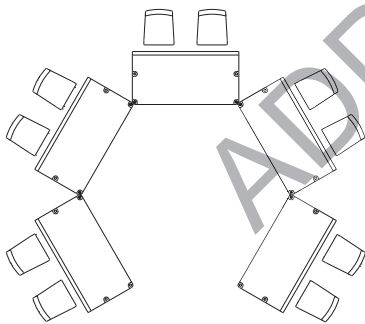
	Metallic	2 Flip Tops w/bridge	iQ Plus PMP	Glides (Deduct)
\$115	\$142	\$253	\$267	-\$200
164	142	253	304	-200
165	142	253	322	-200
250	142	253	367	-200
265	142	253	378	-200
189	142	253	267	-200
170	142	253	304	-200
179	142	253	322	-200
249	142	253	367	-200
269	142	253	378	-200
190	146	253	267	-200
164	146	253	304	-200
172	146	253	322	-200
278	146	253	367	-200
297	146	253	378	-200

\*\* Price for Linoleum add-on must be added to price of W-22DB or W-12DB tops.



iQ Plus Stationary

For additional top sizes see pages 176-197.

Thirty ( 30 ) Year Warranty



# iQ PLUS Folding Tables

## Cast Aluminum Pedestals

iQ Plus Folding

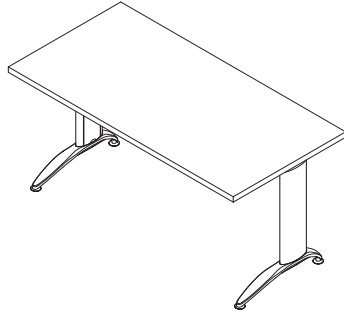

High Pressure Laminate Surface  
Edge Style, Type and Size

Vinyl T-Mold		Rigid PVC	Wood			Specialty PVC
<b>L-21</b>				<b>W-23</b>		
<b>L-18</b>	<b>L-23</b>			<b>W-18</b>	<b>W-19</b>	
<b>L-15</b>	<b>L-20</b>	<b>P-12</b>	<b>W-12</b> √	<b>W-16</b>	<b>W-17</b>	<b>P-14</b>
1/4"x1-1/4"	1/4"x1-3/4"	1/8"x1-1/4"	1/8"x1-1/4"	1-1/4"x1-1/4"	1-1/4"x1-3/4"	2mmx1-1/4"

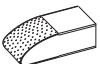

Table Model	Base Model	Unpacked Weight		List Price						
		Standard	Light Weight	Textured & Smooth Pedestal Finishes						
IOF-2460	IOF-22	79	59	\$1172	\$1260	\$1167	\$1365	\$1646	\$1727	\$1157
IOF-2472	IOF-22	90	66	1285	1400	1281	1527	1766	1859	1276
IOF-2484	IOF-22	101	73	1353	1486	1351	1761	2112	2242	1349
IOF-2496	IOF-22	111	79	1519	1693	1517	1907	2357	2510	1522
IOF-3060	IOF-22	93	68	1226	1328	1223	1459	1750	1843	1215
IOF-3072	IOF-22	106	76	1315	1437	1311	1600	1869	1974	1307
IOF-3084	IOF-22	119	84	1412	1559	1408	1910	2140	2272	1409
IOF-3096	IOF-22	133	93	1517	1690	1515	1995	2486	2651	1520
IOF-3660	IOF-28	106	76	1338	1463	1336	1578	1885	1987	1316
IOF-3672	IOF-28	122	86	1389	1523	1387	1720	2022	2140	1370
IOF-3684	IOF-28	138	96	1607	1799	1605	1983	2437	2599	1599
IOF-3696	IOF-28	154	106	1722	1941	1720	2054	2558	2730	1720

ADD 7% TO PRICES

√ W-12 Framed Edge.

Berco Customer Service (888) 772-4788

High Pressure Laminate Surface  
Edge Style, Type and Size

Wood	Comfort Edges		
Euro Wood	Textured Tough Edge 3 Sides PVC	Wood W/PVC 3 Sides	Wood W/3MM Wood 3 Sides
			
W-22	TC-9	WC-9	WC-11
1-1/8"	2"x1-1/4"	2"x1-1/4"	2"x1-1/4"

Vinyl, PVC, Wood Edge, and Euro Wood Laminate Surface

Table Specifications ..... 76  
 How to Order..... 77  
 Surface Selections ..... 198  
 Edge Specifications ..... 199-205  
 Pedestal Finish Selections ..... 207  
 Table and Base Options ..... 208-219  
 Power & Data Options ..... 214-217  
 Design Data ..... 220-227

iQ Plus Folding

Options - Add To List Price

List Price Textured & Smooth Pedestal Finishes				Metallic	iQ Plus PMP	Casters	Light Weight Top
\$1422	\$1277	\$1533	\$1667	\$142	\$304	\$200	\$104
1582	1326	1612	1747	142	322	200	104
1701	1424	1693	1866	142	367	200	180
1846	N/A	1759	1962	142	378	200	180
1488	1252	1572	1747	142	304	200	104
1646	1368	1681	1855	142	322	200	149
1867	1491	1774	1935	142	367	200	180
2152	N/A	1866	2028	142	378	200	180
1548	N/A	1689	1810	146	304	200	149
1776	N/A	1756	1915	146	322	200	180
2117	N/A	1850	2024	146	367	200	180
2216	N/A	1956	2131	146	378	200	180

Table  
Locks "D"  
  
\$66 Per Lock  
Factory Installed  
  
Please Provide  
Table  
Layout Drawing  
Or  
See Page 218  
For Table  
Configurations  
  
Recommended  
For  
Flat Edges Only  
L-18, L-20,  
P-12, W-12,  
W-16, W-17,  
TC-9, WC-9,  
WC-11  
  
Hardware only  
For  
Field Installation  
\$33

ADD 7% TO PRICES

For additional top sizes see pages 176-197.

Thirty ( 30 ) Year Warranty